

Innovative UltraRack™

Paint Stand • Assembly Instructions

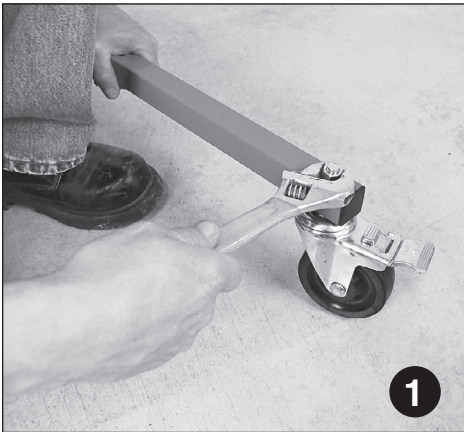

Install Total Lock Wheels.
Secure to support tubes P/N 220-001.

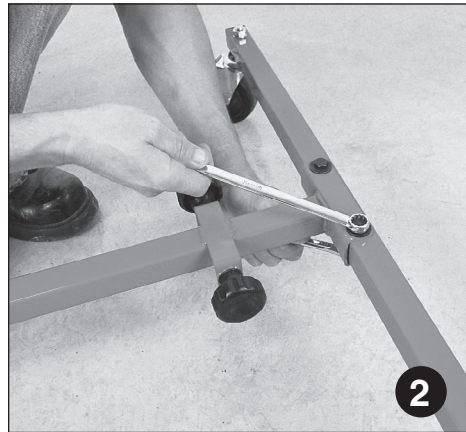

Install Support Tubes to base frame tube (P/N 220-002); tighten firmly.

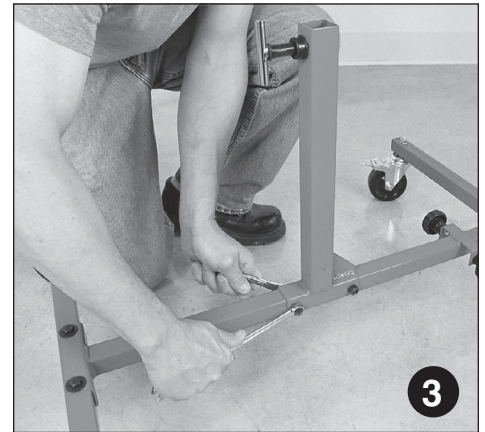

Install Frame Post (P/N 220-003) to frame base tube; tighten firmly.

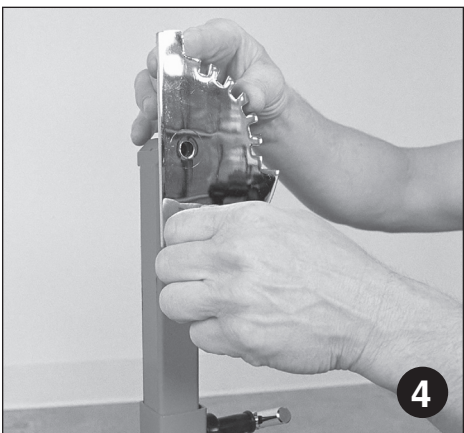

Slide Inside Frame Post (P/N 220-004) into frame post. Install index plate lower bolt (finger-tight only).

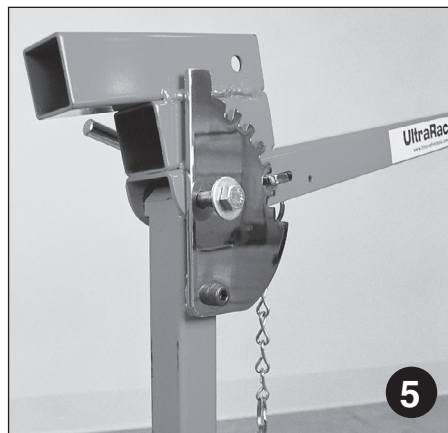

Install Trunnion Bracket (P/N 220-005) using $\frac{3}{8}$ " x 2" cap screw, through upper index plate hole.

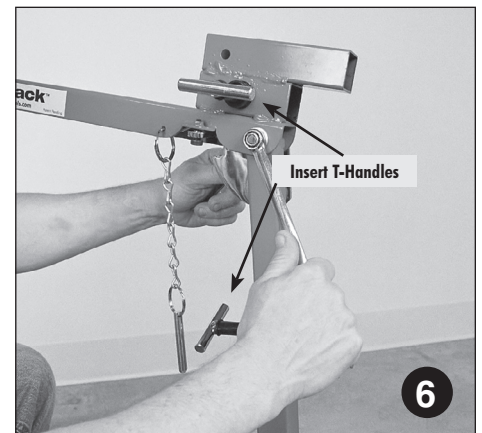

Install Locking Nut to the 2" cap screw from step 5. Do not overtighten. Trunnion Bracket should rotate freely. Now firmly tighten lower index plate bolt.

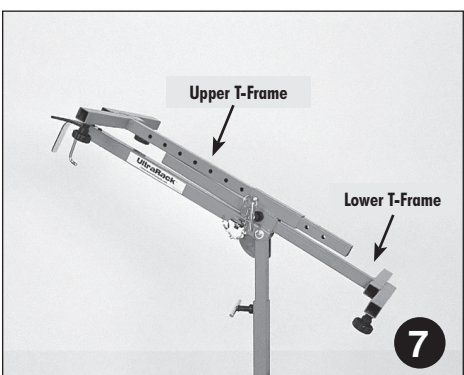

Insert T-Frame Tubes.
Upper T-Frame P/N 220-007.
Lower T-Frame P/N 220-006.

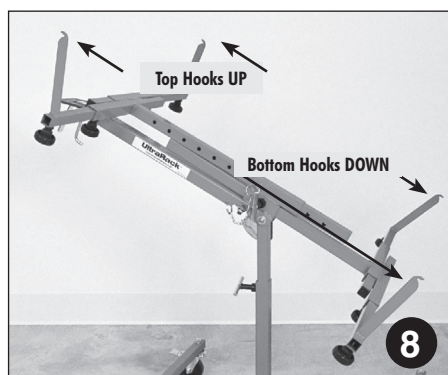

Insert Support Arms.
See arrows - hooks point away from center of UltraRack.



Put Left and Right Extension arms into Storage Position. For use with Pickup tailgates only.

Innovative UltraRack™

Assembly Drawing

