

**M8S  
MT10  
SVN**

- Caisse
- Car-body
- Karosserie
- Scocca
- Caja

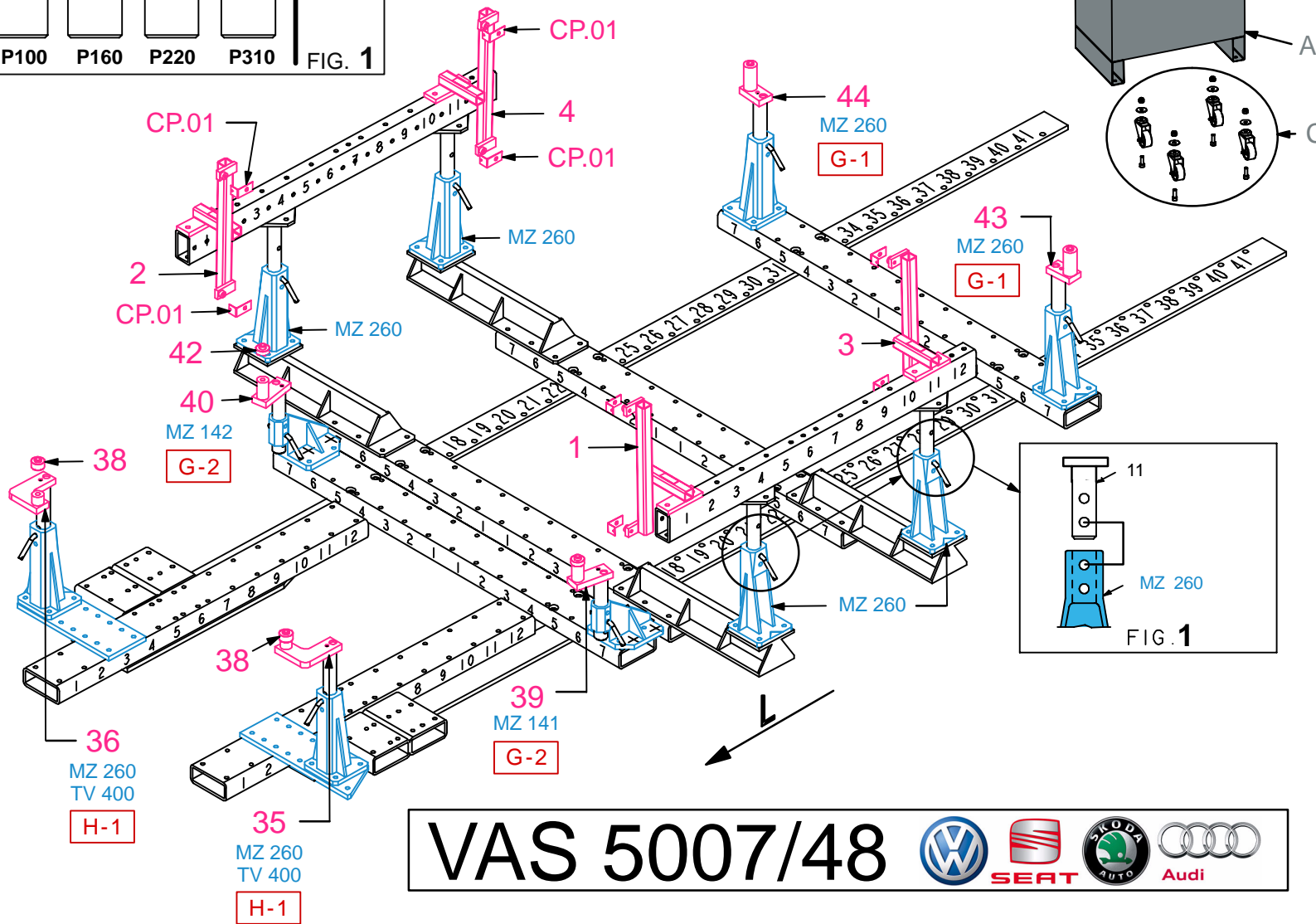
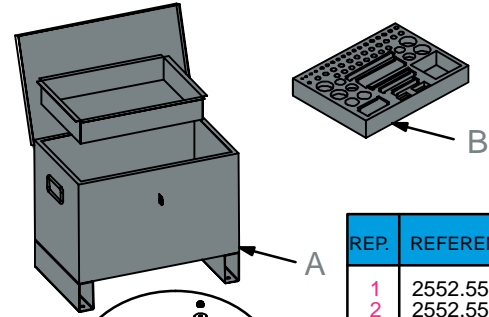

**VAS 5007/48** **VW SEAT SKODA Audi**

REP.	REFERENCE	NB	PDS	Key	Symbol
1	2552.5501	1	2,7		
2	2552.5502	1	2,7	M8-40	
	CP.01	2	0,02		
3	2552.5503	1	2,8	M8-40	
4	2552.5504	1	2,8		
	CP.01	2	0,02		
5	2552.5505	1	2,3		
6	2552.5506	1	2,3		
7	2552.5507	2	0,03		
35	2552.5035	1	1,8		
36	2552.5036	1	1,8		
37	2552.5037	2	0,3	M12-90 + M12	
38	2552.5038	2	0,2	M12x1,50-90	
39	2552.5039	1	1,2		
40	2552.5040	1	1,2		
41	2552.5041	2	0,2	M12-110 + M12	
42	2552.5042	2	0,1	M12x1,50-140	
43	2552.5043	1	1,3		
44	2552.5044	1	1,3		
45	2552.5045	2	0,4	M12-130 + M12	
46	2552.5046	2	0,4	M12x1,50-150	
A	CRM550.01	1	14,8		
B	MR.2552.800	1	0,2		
C	KITCRM.01	1	1,0		
	M 8-40	4			
	M 12-90	2			
	M 12-110	2			
	M 12-130	2			
	M 12x1,50-90	2			
	M 12x1,50-140	2			
	M 12x1,50-150	2			
	M 12	6			

complément au  
complementary set to  
complemento al  
zusatz zu

**VAS 6637 +**  
(2552.500)

**VAS 5007**  
(9113.053)

**VAS 5007/48**  
(2552.800)

46 Kg | 07.10.2010 | VAS5007/48-RVA3-1

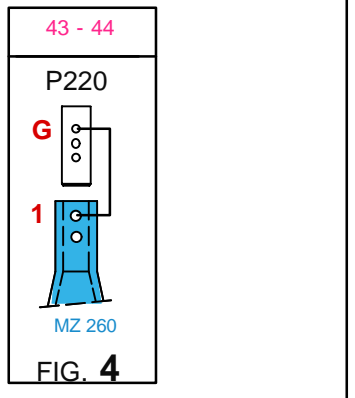
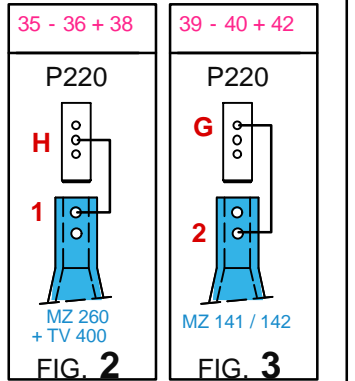
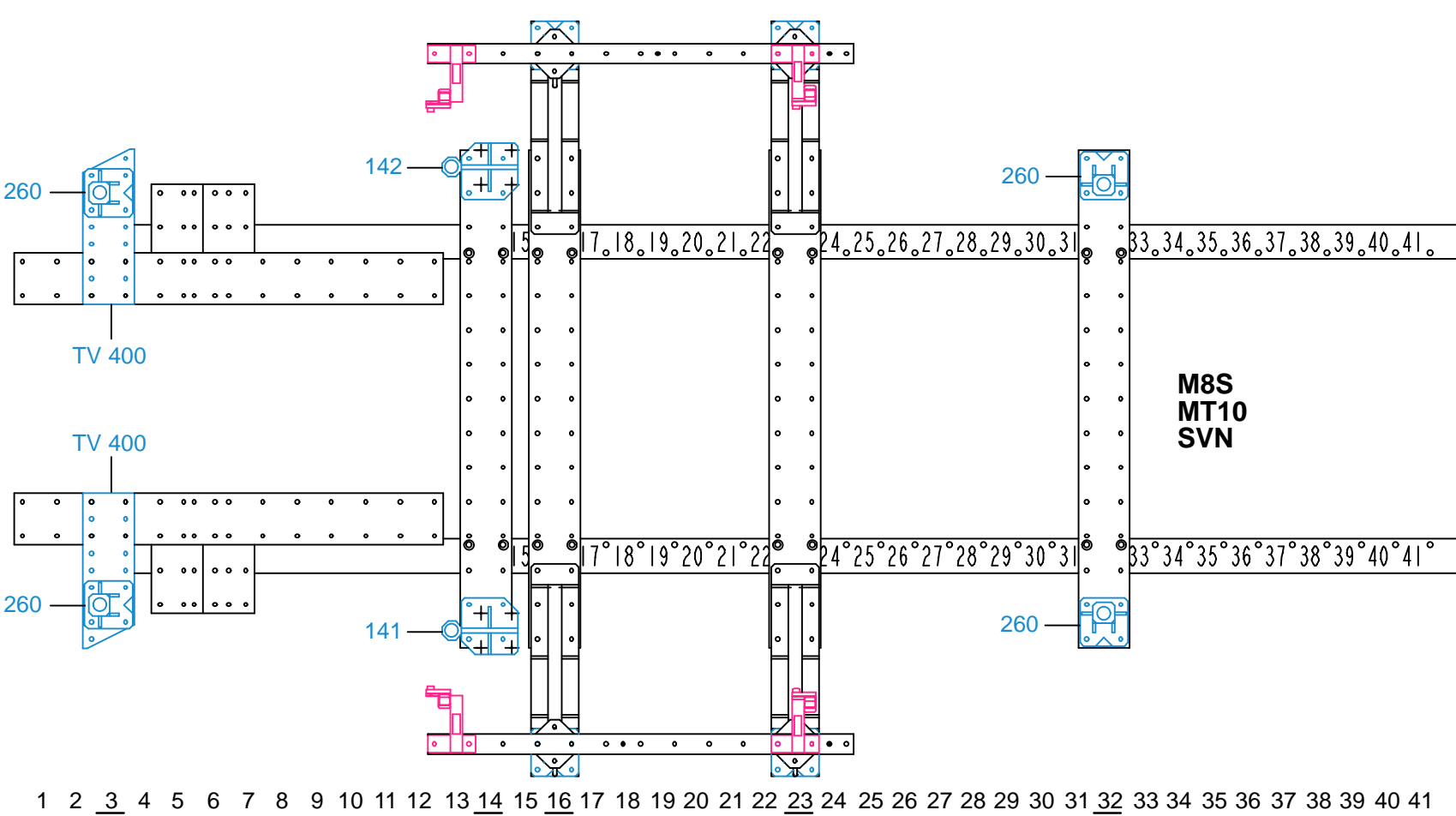

1 2 3 4 5 6 7 8 9 10 11 12 13 14 15 16 17 18 19 20 21 22 23 24 25 26 27 28 29 30 31 32 33 34 35 36 37 38 39 40 41



VAS5007/48-RVA3-1 00

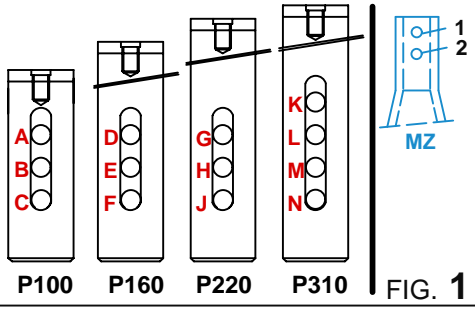

M8S  
MT10  
SVN

- Caisse
- Car-body
- Karosserie
- Scocca
- Caja

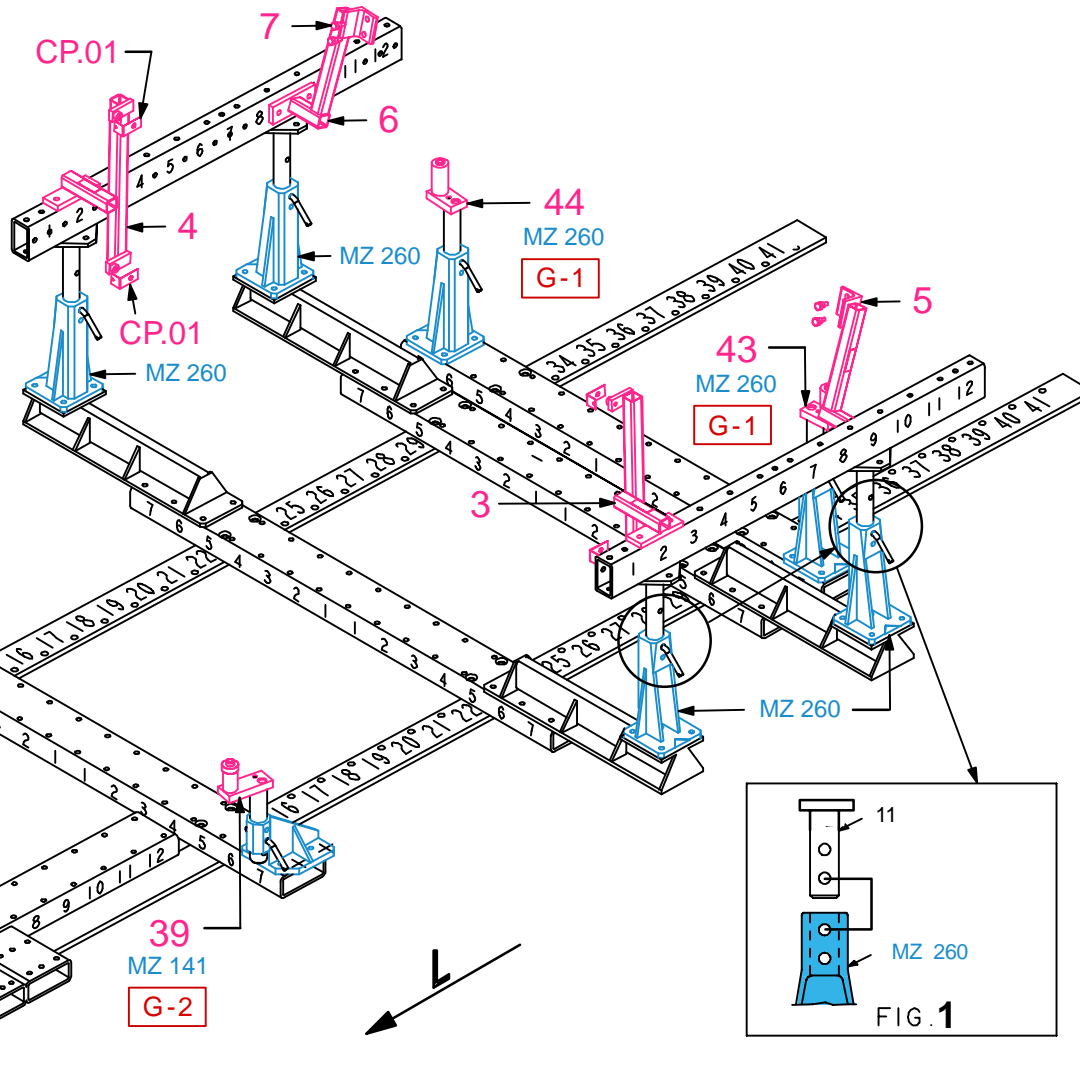

REP.	REFERENCE	NB	PDS	
1	2552.5501	1	2,7	
2	2552.5502	1	2,7	M8-40
	CP.01	2	0,02	
3	2552.5503	1	2,8	M8-40
4	2552.5504	1	2,8	
	CP.01	2	0,02	
5	2552.5505	1	2,3	
6	2552.5506	1	2,3	
7	2552.5507	2	0,03	
35	2552.5035	1	1,8	
36	2552.5036	1	1,8	
37	2552.5037	2	0,3	M12-90 + M12
38	2552.5038	2	0,2	M12x1,50-90
39	2552.5039	1	1,2	
40	2552.5040	1	1,2	
41	2552.5041	2	0,2	M12-110 + M12
42	2552.5042	2	0,1	M12x1,50-140
43	2552.5043	1	1,3	
44	2552.5044	1	1,3	
45	2552.5045	2	0,4	M12-130 + M12
46	2552.5046	2	0,4	M12x1,50-150
A	CRM550.01	1	14,8	
B	MR.2552.800	1	0,2	
C	KITCRM.01	1	1,0	
	M 8-40	4		
	M 12-90	2		
	M 12-110	2		
	M 12-130	2		
	M 12x1,50-90	2		
	M 12x1,50-140	2		
	M 12x1,50-150	2		
	M 12	6		

complément au  
complementary set to  
complemento al  
zusatz zu

**VAS 6637 +**  
(2552.500)

**VAS 5007**  
(9113.053)

**VAS 5007/48** **VW SEAT SKODA Audi**

**VAS 5007/48**  
(2552.800)

46 Kg | 07.10.2010 | VAS5007/48-RVA3-1

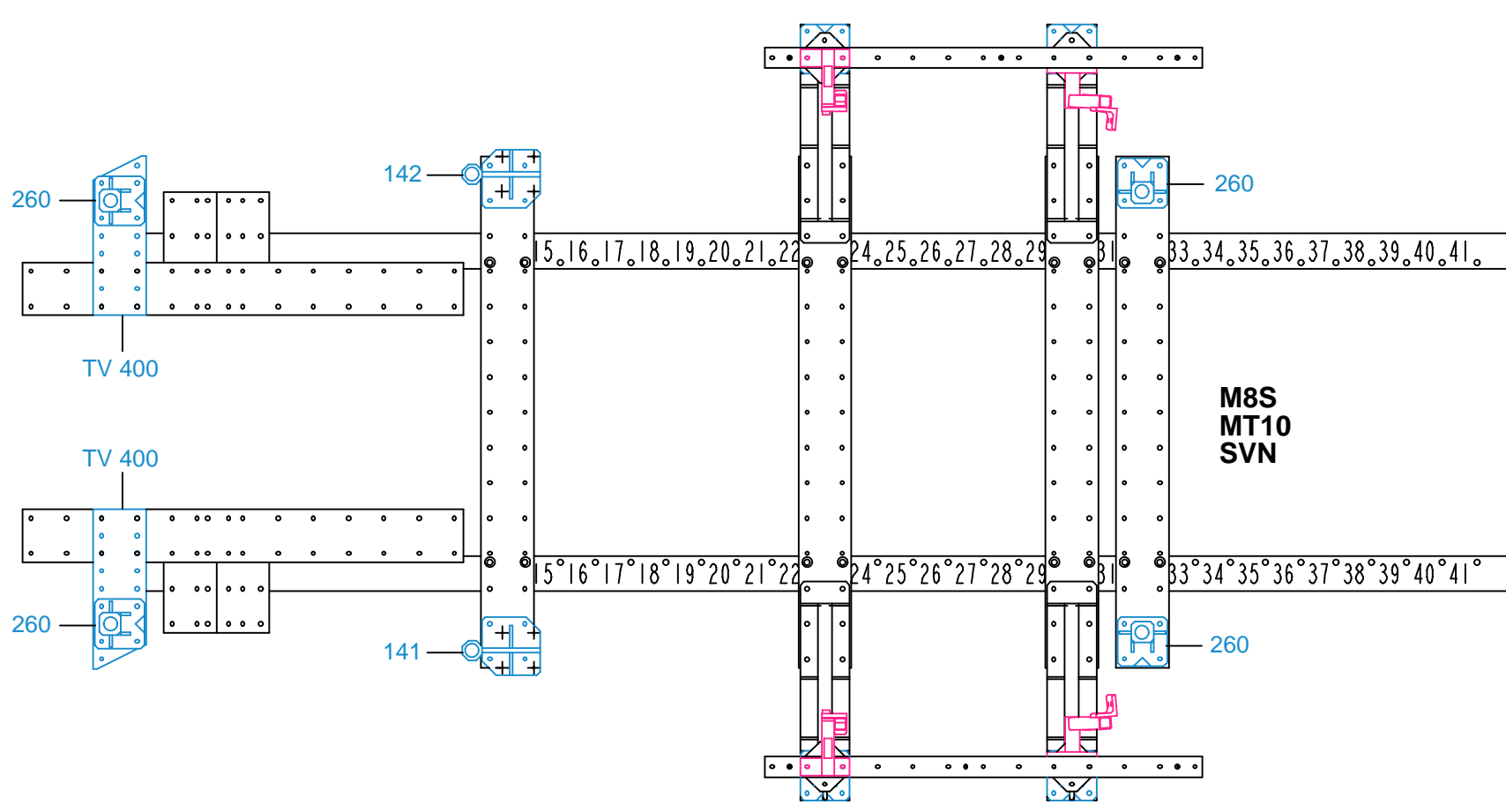

1 2 3 4 5 6 7 8 9 10 11 12 13 14 15 16 17 18 19 20 21 22 23 24 25 26 27 28 29 30 31 32 33 34 35 36 37 38 39 40 41



VAS5007/48-RVA3-1 00

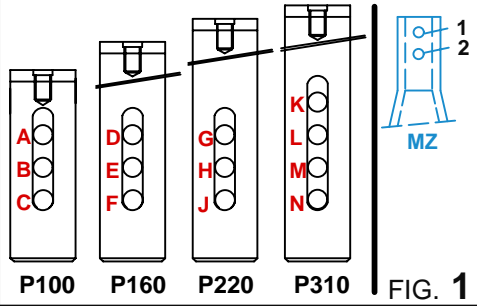

- Chassis
- Frame
- Rahmen
- Telaio
- Chasis

**M8S  
MT10  
SVN**

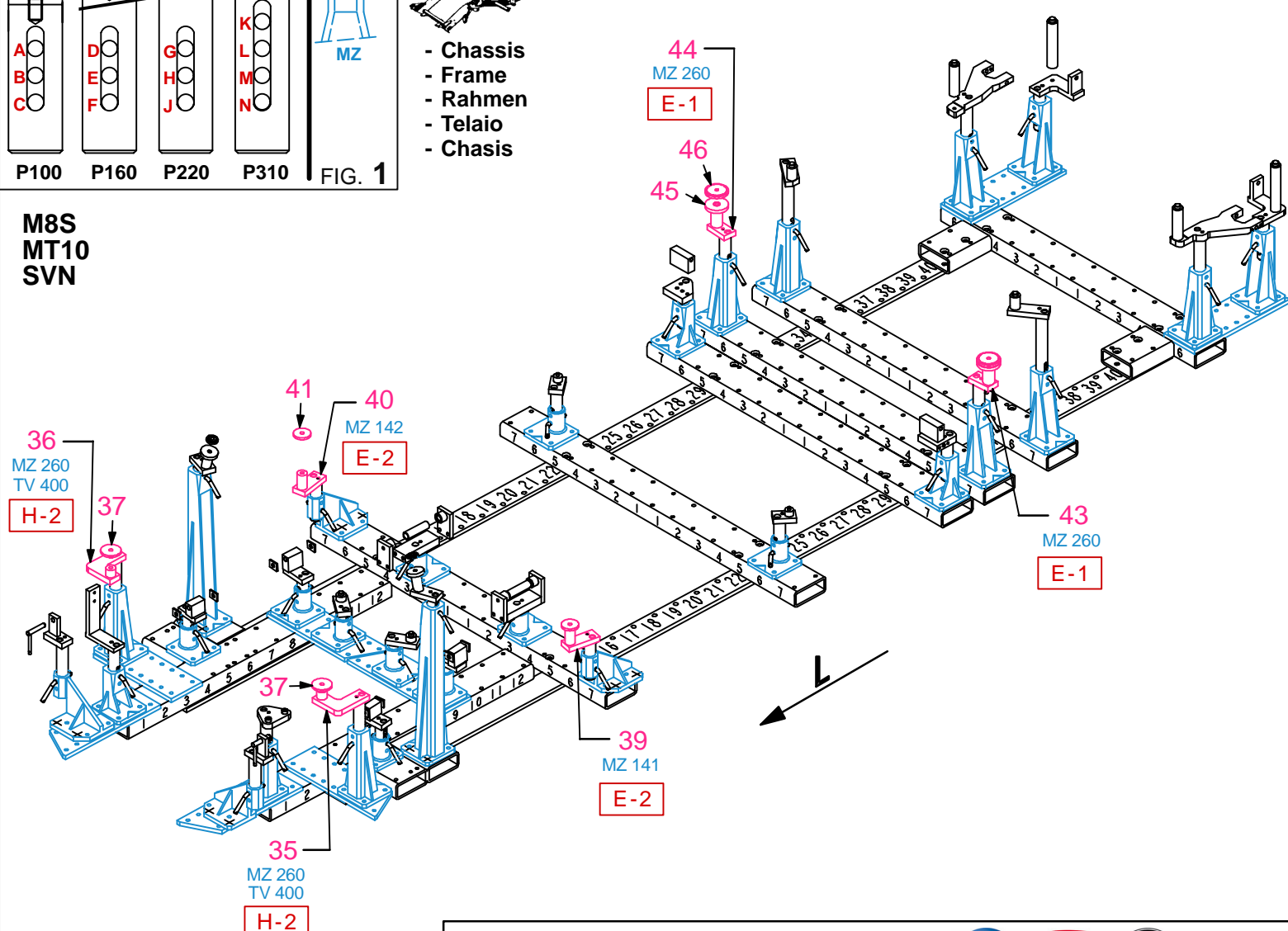

REP.	REFERENCE	NB	PDS	Key	Symbol
1	2552.5501	1	2,7		
2	2552.5502	1	2,7	M8-40	
	CP.01	2	0,02		
3	2552.5503	1	2,8	M8-40	
4	2552.5504	1	2,8		
	CP.01	2	0,02		
5	2552.5505	1	2,3		
6	2552.5506	1	2,3		
7	2552.5507	2	0,03		
35	2552.5035	1	1,8		
36	2552.5036	1	1,8		
37	2552.5037	2	0,3	M12-90 + M12	
38	2552.5038	2	0,2	M12x1,50-90	
39	2552.5039	1	1,2		
40	2552.5040	1	1,2		
41	2552.5041	2	0,2	M12-110 + M12	
42	2552.5042	2	0,1	M12x1,50-140	
43	2552.5043	1	1,3		
44	2552.5044	1	1,3		
45	2552.5045	2	0,4	M12-130 + M12	
46	2552.5046	2	0,4	M12x1,50-150	
A	CRM550.01	1	14,8		
B	MR.2552.800	1	0,2		
C	KITCRM.01	1	1,0		
M 8-40		4			
M 12-90		2			
M 12-110		2			
M 12-130		2			
M 12x1,50-90		2			
M 12x1,50-140		2			
M 12x1,50-150		2			
M 12		6			

complément au  
complementary set to  
complemento al  
zusatz zu

**VAS 6637 +**  
(2552.500)

**VAS 5007**  
(9113.053)

**VAS 5007/48** **VW SEAT SKODA Audi**

**VAS 5007/48**  
(2552.800)

46 Kg | 07.10.2010 | VAS5007/48-RA3-2

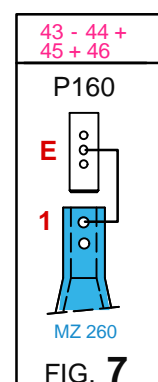
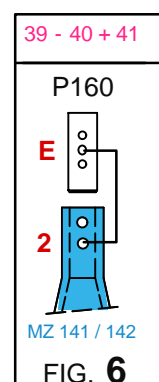
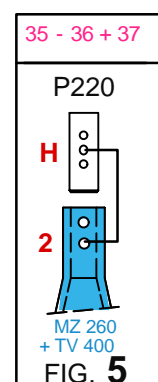
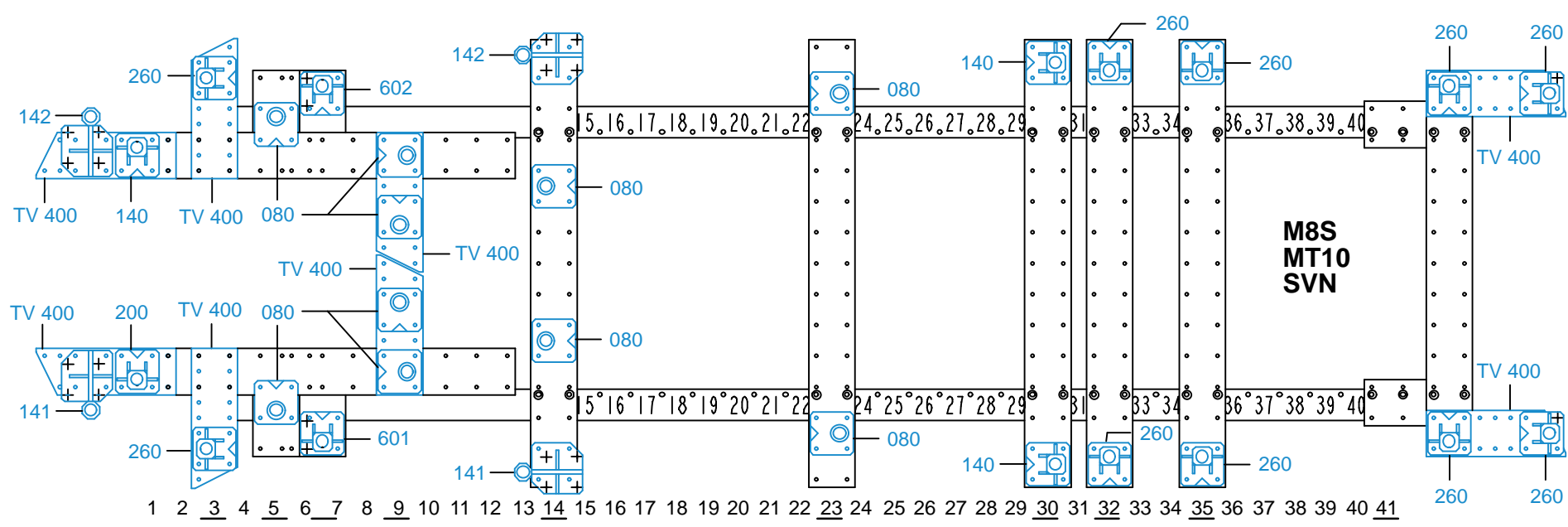

VAS5007/48-RA3-2 00